

# HUMAN BODY VIBRATION EXPOSURE AND ITS MEASUREMENT

By *G.Rasmussen* <http://www.zainea.com/body.htm>

## ABSTRACT

Experimental data collected over the years, for defining limits of vibration exposure to human beings, have resulted in a set of vibration criteria specified in ISO Standard 2631. In this article, instrumentation requirements for evaluation of the responses of humans to vibration according to these criteria are described, as well as some of the pitfalls to be avoided during these measurements.

Exposure limits for vibration transmitted to the hands and arms of operators of vibrating tools have been suggested in Draft Standard ISO/DIS 5349. A special hand adaptor developed for the measurement of hand-arm vibration transmitted from the handle of such tools is described in the article, and measurement results obtained with it on a chip hammer are illustrated.

## Introduction

The human body is both physically and biologically a "system" of an extremely complex nature. When looked upon as a mechanical system it can be considered to contain a number of linear as well as non-linear "elements", and the mechanical properties are quite different from person to person.

Biologically the situation is by no means simpler, especially when psychological effects are included. In considering the response of man to vibrations and shocks it is necessary, however, to take into account both mechanical and psychological effects.

Knowledge about comfort and fatigue-decreased proficiency is based on statistical data collected under practical and experimental conditions. Because experiments with human beings are difficult, time consuming and in extreme cases unesthetic, much of the knowledge about damaging effects has been obtained from experiments on animals. It is, of course, not always possible to "scale" results obtained from animal experiments to reactions expected from man, but nevertheless such experiments often result in valuable information.

Considering first the human body as a mechanical system it may, at low frequencies and low vibration levels, be roughly approximated by a linear lumped parameter system of the type shown in Fig. 1. One of the most important parts of this system with respect to vibration and shock effect seems to be the part marked "thorax-abdomen system". This is due to a distinct resonance effect occurring in the 3-6 Hz range as indicated on Fig. 2 and 3 and which makes efficient vibration isolation of a sitting or standing person very difficult. A further resonance effect.

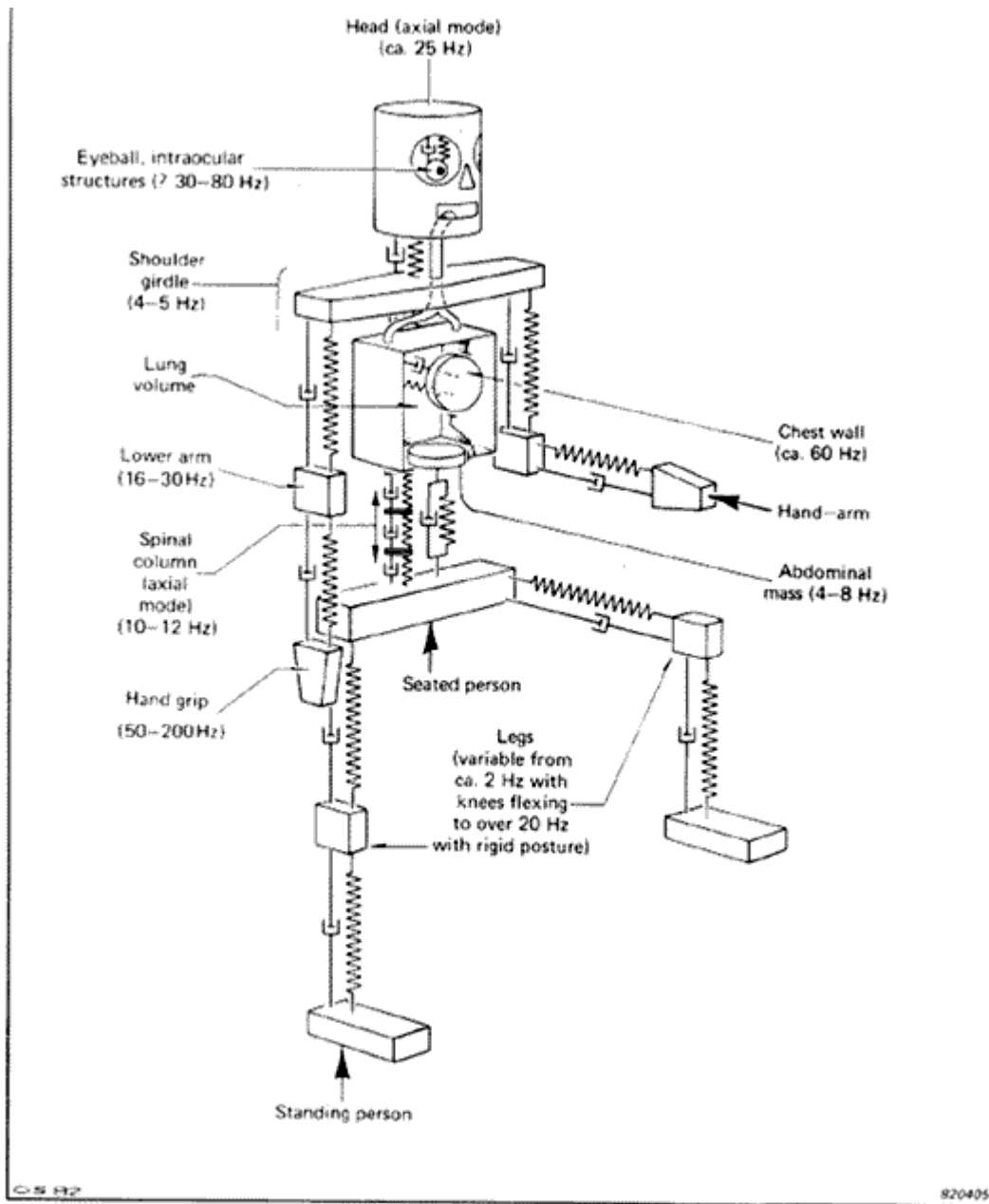

*Fig. 1. Simplified mechanical system representing the human body standing on a vertically vibrating platform*

*Fig. 1. Simplified mechanical system representing the human body standing on a vertically vibrating platform is found in the 20 to 30 Hz region and is caused by the head-neck-shoulder system, Fig. 3.*

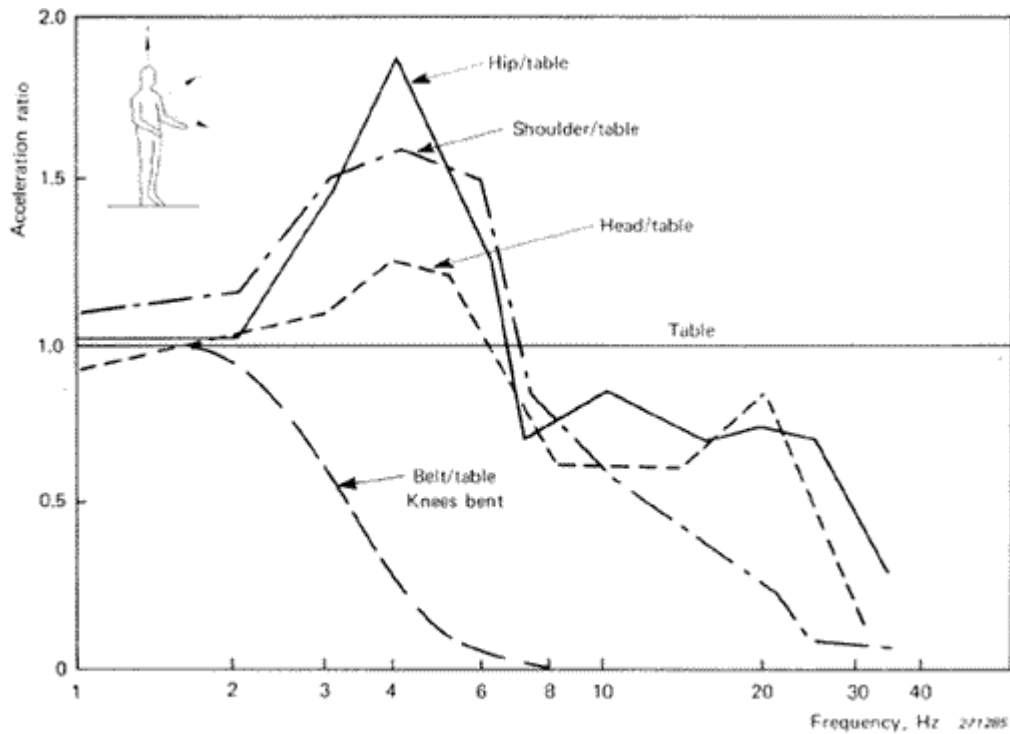

Fig. 2. Transmissibility of vertical vibration from table to various parts of the body of a standing human subject as a function of frequency

Fig. 2.

Also in the region 60 to 90 Hz disturbances are felt which suggest eyeball resonances, and a resonance effect in the lower jaw-skull system has been found between 100 and 200 Hz.

Above 100 Hz, simple lumped parameter models like that shown in Fig. 1 are not very useful. It is then necessary to apply continuous structural analysis methods which become very complex. By such methods, however, it has been shown that for the skull itself, the fundamental mode of vibration seems to be in the region of 300 - 400 Hz with resonances for higher modes around 600 to 900 Hz. At still higher frequencies use must be made of wave theory both in the form of shear waves and of compressional waves (sound waves).

From a shock and vibration point of view the low frequency range may be considered most important. Some very interesting measurements have here been made by von Békésy and concern the attenuation of vibration along the human body. The results obtained at 50 Hz are reproduced in Fig. 4 and show that the attenuation from foot to head is of the order of 30 dB. Similarly, the attenuation from hand to head is roughly 40 dB.

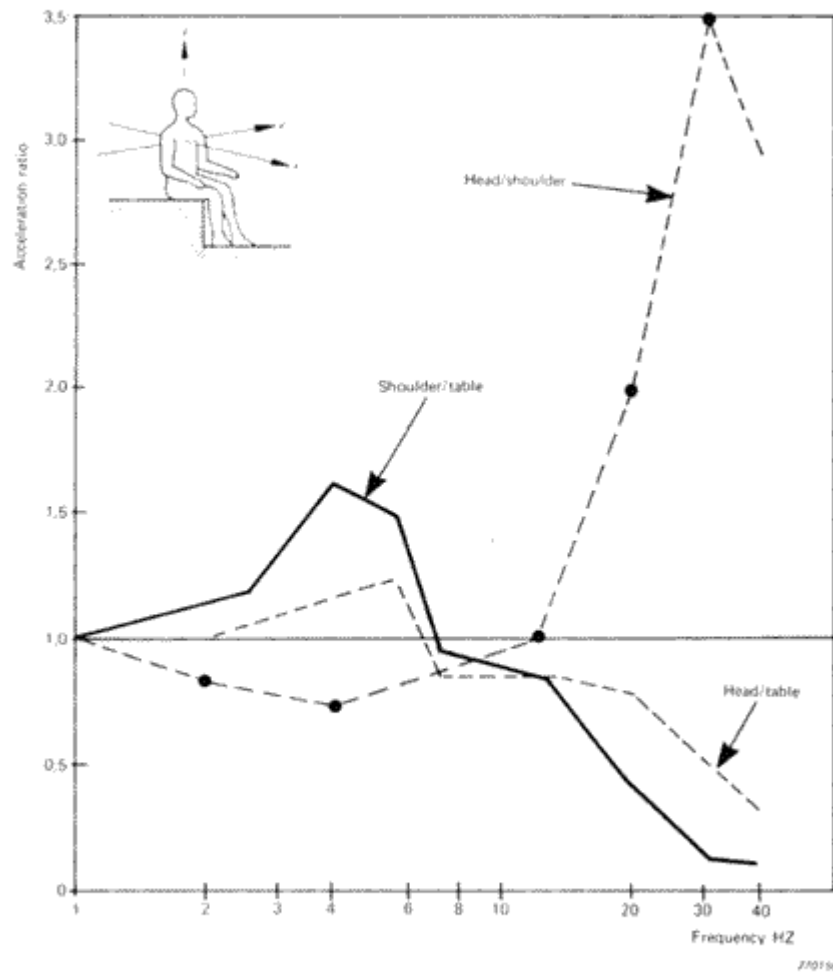

Fig. 3. Transmissibility of vertical vibration from table to various parts of a seated human subject as a function of frequency

Fig. 3.

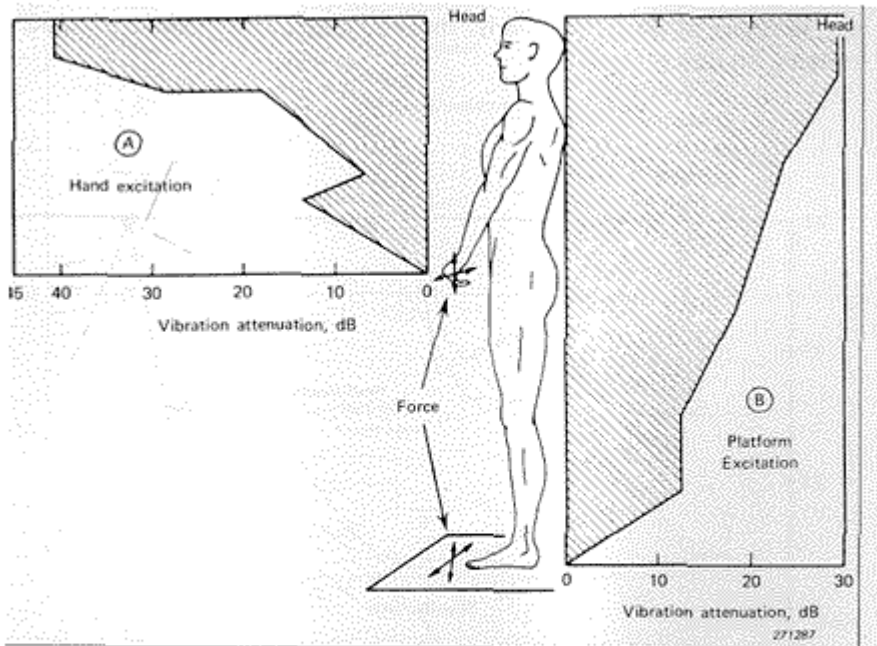

Fig. 4. Attenuation of vibration at 50 Hz along human body. The attenuation is expressed in decibels below values at the point of excitation. For excitation of (A) hand, and (B) platform on which subject stands

Fig. 4. Attenuation of vibration at 50 Hz along human body. The attenuation is expressed in decibels below values at the point of excitation. For excitation of (A) hand, and (B) platform on which subject stands

#### Vibration Exposure Criteria

Apart from the mechanical responses mentioned above, both physiological and psychological effects are observed. Although these effects are rather complex and difficult to measure, it seems that physiological results obtained from animal experiments also apply to man to a certain extent. These experiments have been mostly concerned with changes in food assimilation, muscular activity, reproductive activity etc. as well as actual internal injury.

Psychological effects such as perception, discomfort, and pain, have recently been studied in some detail. Most of the studies have been carried out on vehicle drivers and aircraft pilots, whose ability to perform complex tasks under adverse environmental conditions, including vibration, is particularly important. The data available is therefore mainly for sitting or standing subjects. The recent ISO 2631 - 1978

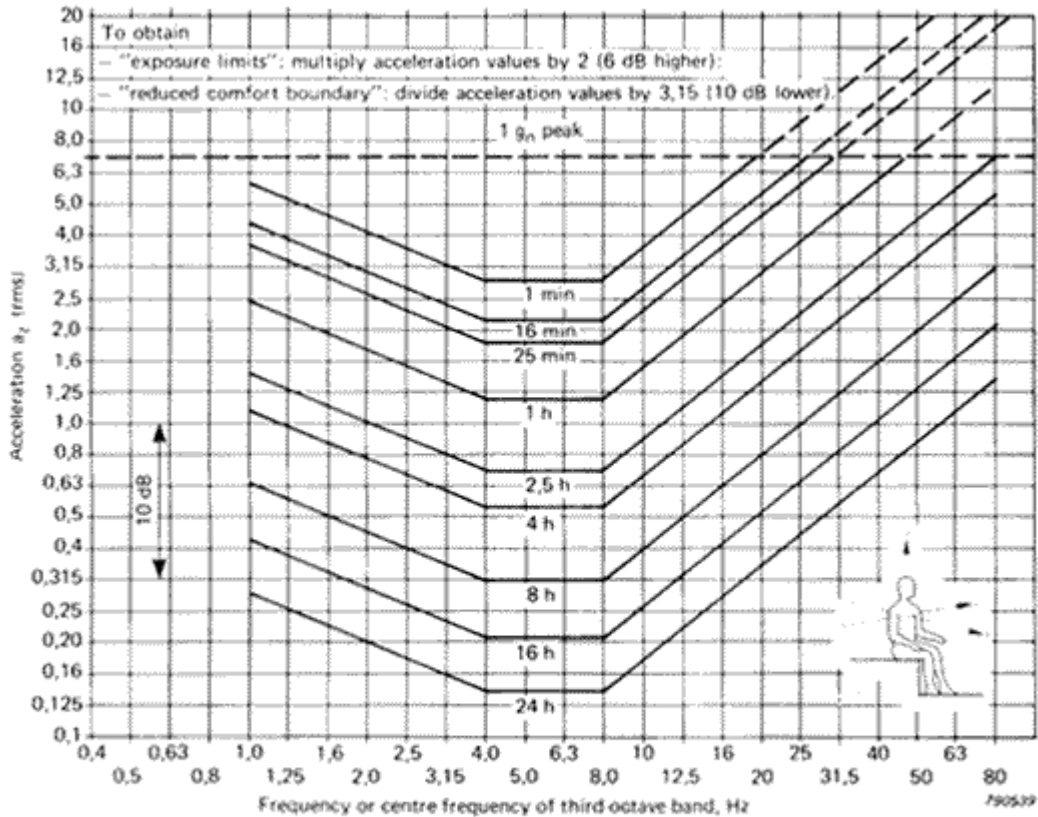

**Fig. 5. Vertical vibration exposure criteria curves defining equal fatigue-decreased proficiency boundaries**

*Fig. 5. Vertical vibration exposure criteria curves defining equal fatigue-decreased proficiency boundaries*

standard brings this data conveniently together as a set of vibration criteria curves for vertical and lateral vibration over the frequency range 1 to 80 Hz. These are shown in Figs.5 (vertical) and 6 (lateral), and apply to vibration transmitted to the torso of a standing or sitting person in the axis system indicated.

Vibration at frequencies below 1 Hz occurs in many forms of transport and produces effects, e.g. Kinetosis (motion sickness), which are completely different in character from those produced at higher frequencies. These effects cannot be simply related to the three parameters of the exciting motion, intensity, duration, and frequency, as has been possible in the range from 1 Hz to 80 Hz. In addition, human reaction to vibration below 1 Hz is extremely variable and seems to depend on a large number of external factors which have nothing to do with the motion, e.g. age, sex, vision, activity, odours. Despite this variability and the limited amount of data available, an attempt has been made to formulate tentative standards for the frequency range from 1 Hz down to 0,1 Hz in an addendum to the previously mentioned Standard for whole-body vibration i.e. ISO 2631.

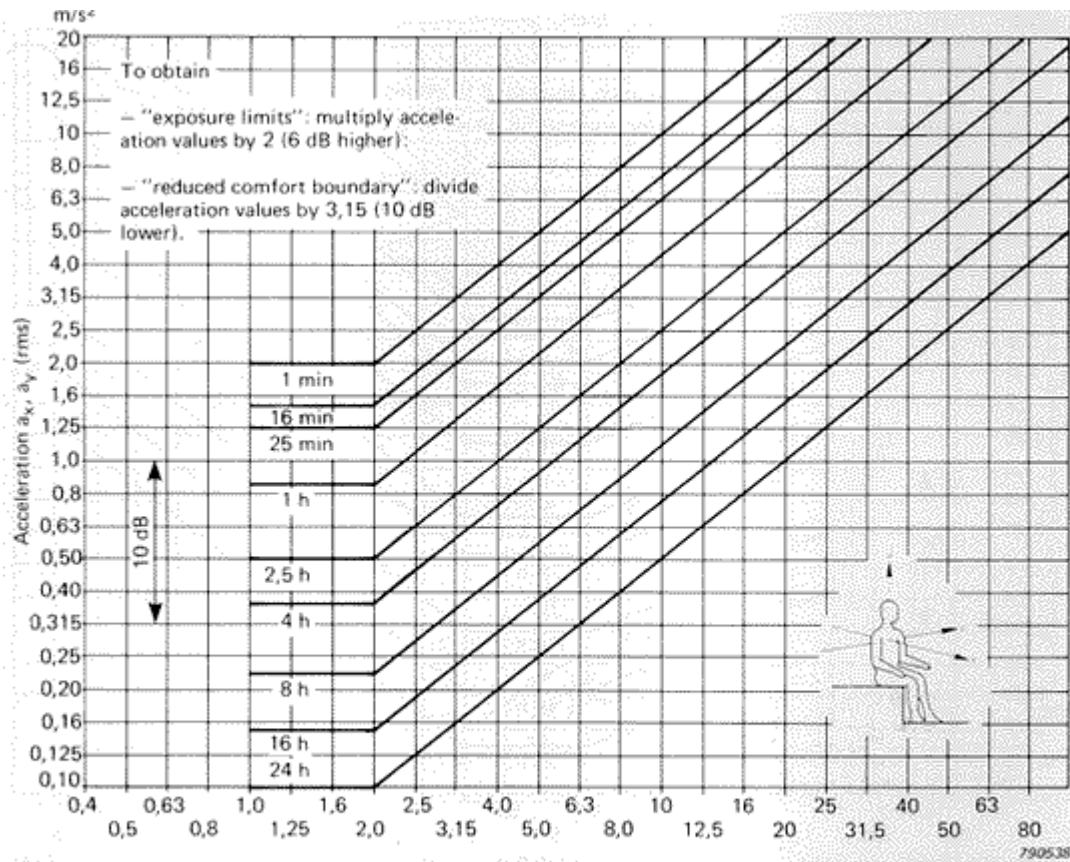
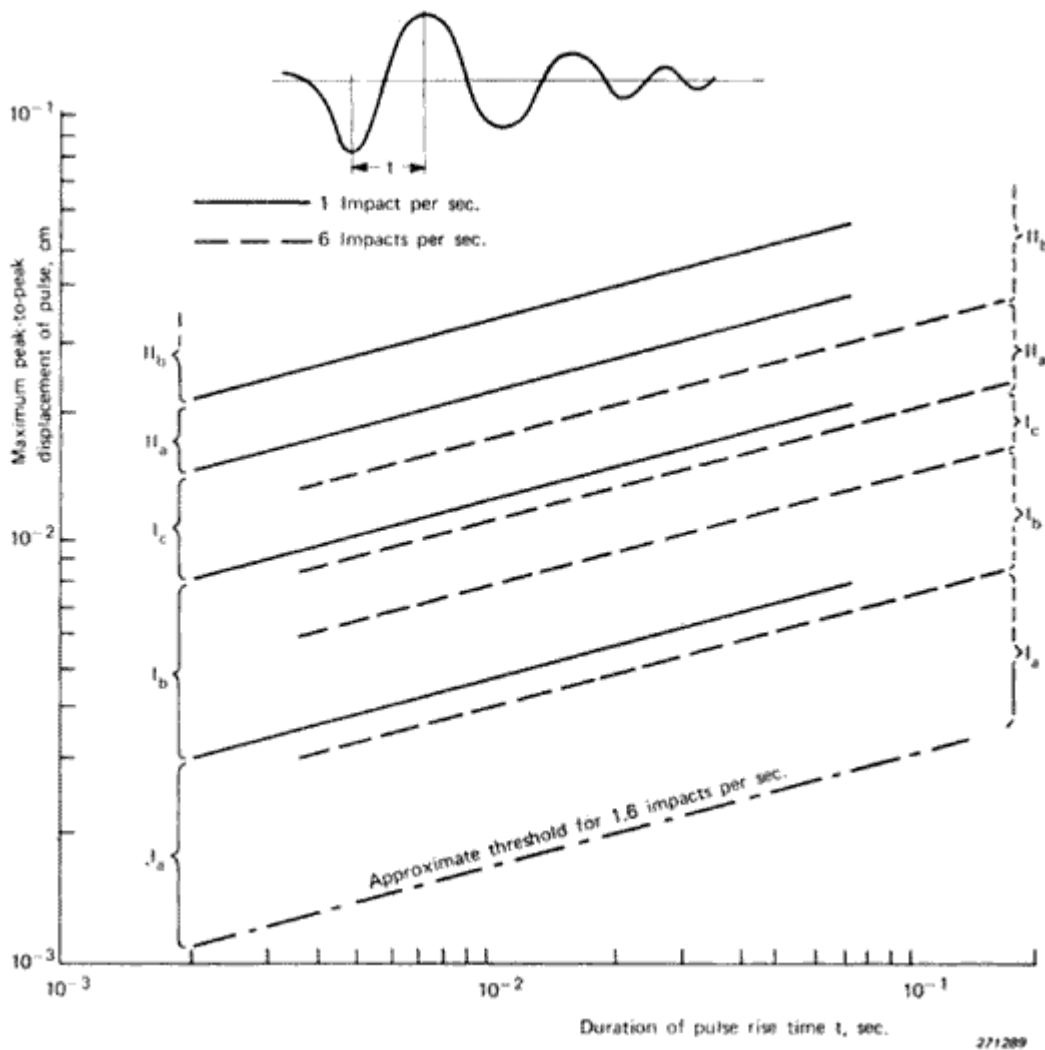

Fig. 6. Lateral vibration exposure criteria curves defining equal fatigue-decreased proficiency boundaries

Fig. 6.

Above 80 Hz, the sensations and effects are very dependent upon local conditions at the point of application, e.g. the actual direction, position and area over which the vibration is transmitted, and upon the damping at this point, e.g. due to clothing or footwear. These external factors heavily influence the response of the skin and superficial tissue chiefly affected by frequencies above 80 Hz. It is thus generally not possible at present to state valid criteria outside the stated range, 1 Hz to 80 Hz.



*Fig. 7. Tolerance of human subjects in the standing or supine position to repetitive vertical impact*

*pulses representative of impacts from pile drivers, heavy tools, heavy traffic etc. Subjective reaction*

*is plotted as a function of the maximum displacement of the initial pulse and its rise time. The*

*numbers indicate the following reactions for the areas between the lines: I a, threshold of perception;*

*I b, for easy perception; I c, of strong perception, annoying; II a, very unpleasant, potential danger*

*for long exposures; II b, extremely unpleasant, definitely dangerous. The decay process of the*

*impact pulses was found to be of little practical significance*

The vibration levels indicated by the curves in Figs.5 and 6 are given in terms of RMS acceleration levels which produce equal fatigue-decreased proficiency.



Exceeding the exposure specified by the curves will, in most situations cause noticeable fatigue and decreased job proficiency in most tasks. The degree of task interference depends on the subject and the complexity of the task but the curves indicate the general range for onset of such interference and the time dependency observed.

An upper bound to exposure considered acceptable (hazard to health as well as performance) is taken to be twice as high as (6 dB above) the "fatigue-decreased proficiency" boundary shown in Fig. 5 while the "reduced comfort boundary" is assumed to be about one third of (10 dB below) the stated levels.

These criteria are presented as recommended guidelines or trend curves rather than firm boundaries classifying quantitative biological or psychological limits. They are intended only for situations involving healthy, normal people considered fit for normal living routines and the stress of an average working day.

There are, as yet, no firm criteria for purely angular vibration equivalent to those for purely translational vibration as described above. In practice, angular motion (i.e. in yaw, roll and pitch) whose centres of rotation lie at a distance from the point of application to the body, can be adequately approximated by purely translatory motion. However, there is much current work aimed at the eventual definition of criteria curves similar to those of Figs.5 and 6 for translatory vibration. Finally, Fig. 7 indicates the tolerance of human subjects to single shock acceleration pulses of the type produced in the floor near drop forges or similar equipment (results from a single study).

Symptoms for vibration exposure at frequencies of 1 to 20 Hz are shown in Table 1. The frequency ranges given are those where the symptoms are most predominant.

| Symptoms                         | Frequency |
|----------------------------------|-----------|
| General feeling of discomfort    | 4-9       |
| Head symptoms                    | 13-20     |
| Lower jaw symptoms               | 6-8       |
| Influence on speech              | 13-20     |
| "Lump in the throat"             | 12-16     |
| Chest pains                      | 5-7       |
| Abdominal pains                  | 4-10      |
| Urge to urinate                  | 10-18     |
| Increased muscle tone            | 13-20     |
| Influence on breathing movements | 4-8       |
| Muscle contractions              | 4-9       |

*Table 1*

#### Hand-arm Vibration Exposure Criteria

Hand-arm vibration is the second large problem area where transmission into the human body is concerned. It is, however, rather different from whole-body vibration in the type of problems to which it gives rise. Whereas vibration transmitted into the standing or seated body normally gives rise to problems of a general nature, e.g.

motion sickness, discomfort, reduced-working efficiency, etc., vibration applied to the hand-arm may, in addition, produce actual physical damage locally if the level and exposure times are sufficiently high.

Vibration levels encountered in many commonly used power tools are sufficiently high to cause damage when operated for durations common in industry. Typical of these power tools are chipping hammers, power grinders, hammer drills, and chain saws, found in widespread use in the mining, construction, manufacturing and forestry industries. Vibration may be transmitted into the body from a vibrating tool or hand-held workpiece via one or both arms simultaneously, causing, at lower levels, discomfort and reduced working efficiency. At higher levels and longer exposure periods, diseases affecting the blood vessels, joints and circulation occur. Severe exposure leads to a progressive circulation disorder in the part of the body suffering the highest level of vibration, usually the fingers or hand where hand-held tools are concerned. This is variously known as "dead hand", vibration-induced white finger, or Raynaud's disease. In extreme cases this leads to permanent damage or gangrene. These diseases and their causes are currently being extensively investigated both by medical and engineering researchers.

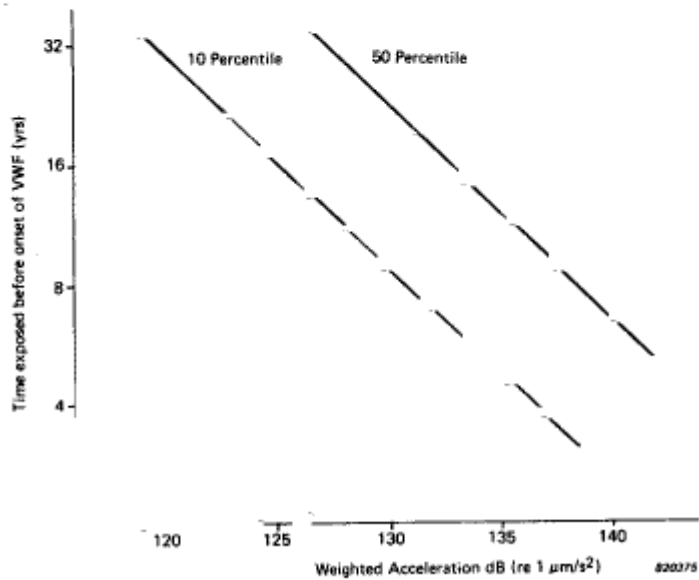
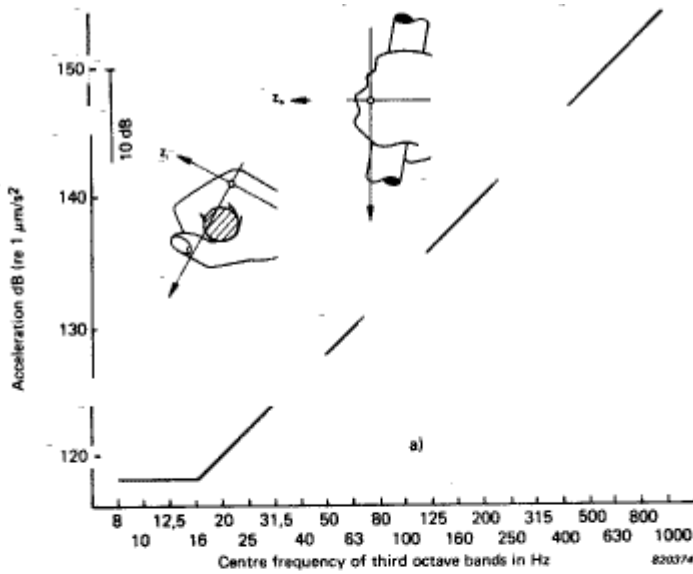

*Fig. 8. a) Exposure guidelines for vibration transmitted to the hand  
b) Time Exposure versus overall weighted acceleration*

*Fig. 8. a) Exposure guidelines for vibration transmitted to the hand  
b) Time Exposure versus overall weighted acceleration*

A very recent ISO draft proposal (5349) attempts to gather current knowledge into a convenient form and to enable conclusions to be drawn about the damage risk of practically measured vibration exposures. The suggested guideline levels are shown in Fig. 8.a) and cover the frequency range from 8 Hz to 1 kHz. Although exposure curves for both third octave and octave bands are presented, third octaves are recommended as these are likely to be more stringent than octaves when applied to the discrete frequency spectra often encountered in rotating hand-held tools. It

should be noted that the current trend is to recommend the use of standardized 1/3 octave filter analysis especially in research. Practical regulatory measurements are recently recommended to be carried out using overall weighting for one figure reading as shown later in this article. Overall weighted acceleration versus time exposure relationship is shown in Fig.8.b) according to A.J.Brammer, NRC, Canada. Most of the data used to derive the curves were from pure sine or narrow band investigations and they are therefore mainly applicable to that type of excitation. However, they may be provisionally applied to repeated shock and other types of markedly non-sinusoidal excitation, in which case a measure of the crest factor should be determined.

#### Measurement of Human Vibration

Techniques for measuring vibration exposure have for many years been less coordinated than desirable. The data presented sometimes lack proper description of the instrumentation used to acquire it and of the important instrumentation characteristics. The descriptors used to characterize a signal are very important.

Possible descriptors, (Fig. 9) which may all be seen used in the current literature, are:

positive peak negative peak maximum peak peak - peak

peak level (bandwidth limited)

max. r.m.s. level (bandwidth and time constant required) Leq time (bandwidth limited) (time required)

60 sec Leq (bandwidth limited) max. r.m.s. 125 m/sec max. r.m.s. 1 sec

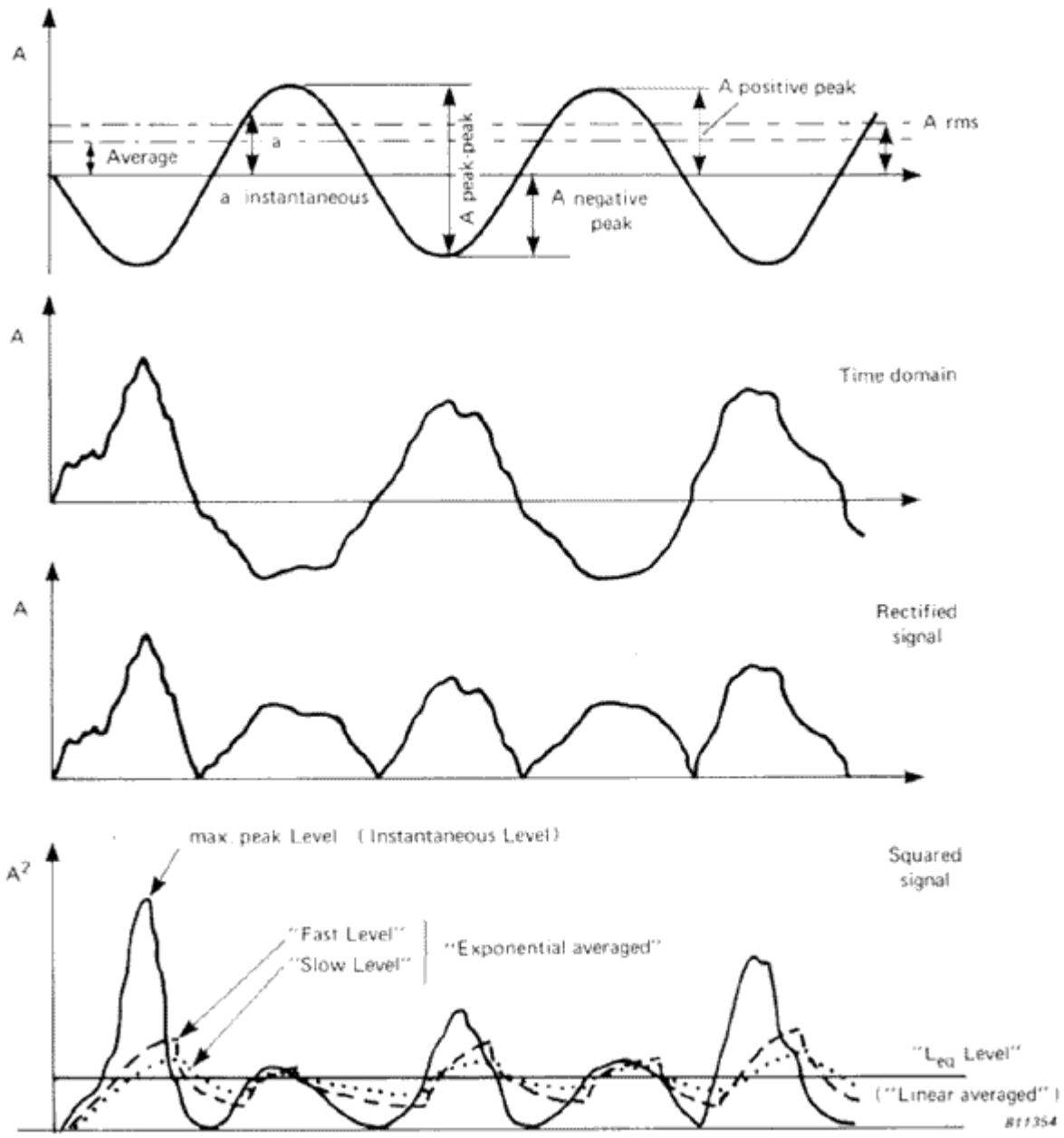

Fig. 9. Signal Detection

Fig. 9. Signal Detection

$$\text{crest factor} = \frac{\text{peak}}{\text{r.m.s.}} \quad (\text{not defined})$$

$$\text{crest factor} = \frac{\text{peak level}}{60 \text{ sec } L_{eq}}$$

$$\text{Kurtosis} = \frac{\int_{-\infty}^{\infty} (x - \bar{x})^4 P(x) dx}{\sigma^4}$$

$$L_{eq} \text{ dose in } \% \quad L_{eq} = 10 \log \frac{1}{T} \int_0^T \left( \frac{a(t)}{10^{-6}} \right)^2 dt$$

where  $L_{eq}$  is in dB re.  $10^{-6} \text{ ms}^{-2}$  and  $a(t)$  is frequency weighted acceleration in  $\text{ms}^{-2}$ .

Basically, vibration of man is measured in acceleration units  $\text{m/s}^2$  r.m.s. of a 1/3 octave frequency band (or possibly 1 octave bands for hand-arm vibration) over the frequency range of interest. The level of vibration may also be quoted in logarithmic units in terms of dB re  $1 \mu\text{m/s}^2$ .

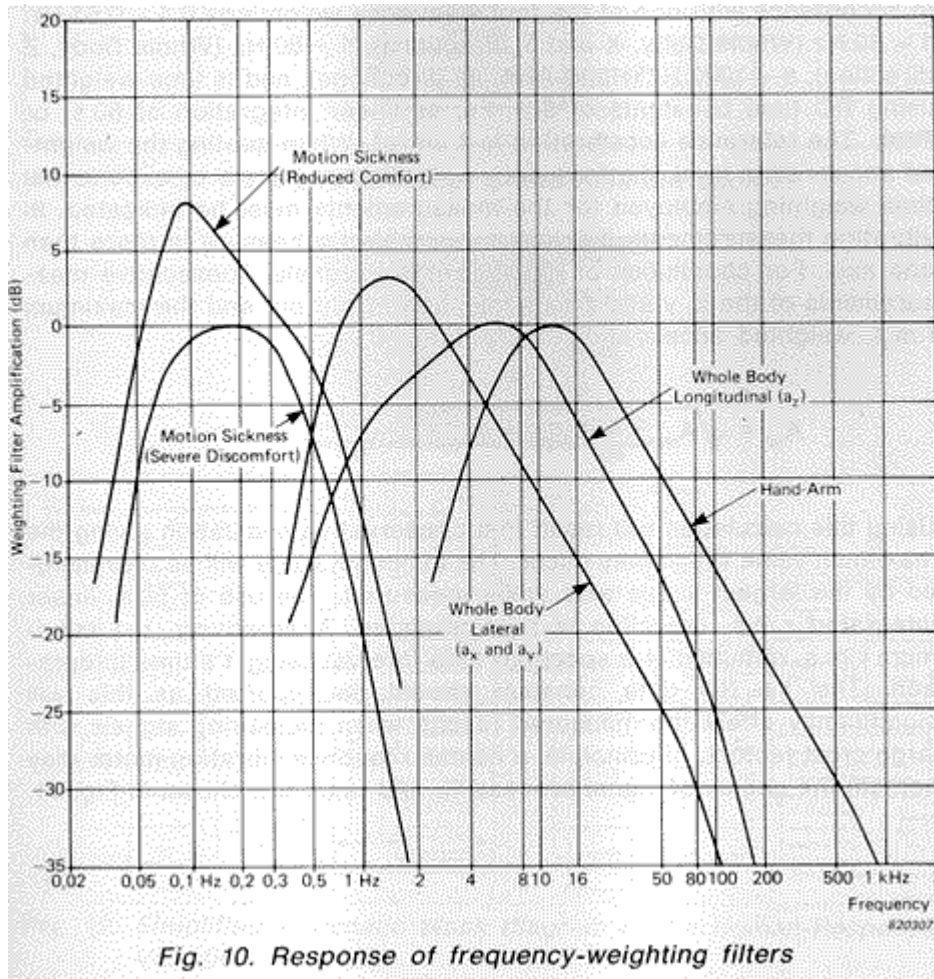

Fig. 10. Response of frequency-weighting filters

Fig. 10. Response of frequency-weighting filters

This logarithmic representation of amplitudes is particularly useful for quoting overall weighted levels, where any resemblance with the  $m/s^2$  is lost due to the weighting. The standards for Measurement of Human Vibration for instance ISO 2631 - 1978 take the relationship between time versus level into consideration. It thus gives exposure levels or doses in percent of permitted vibration exposure for up to 24 hours. This makes the use of an overall weighting important when single figure values are required for regulatory purposes (see Fig. 10).

The weighted vibration level is expressed in "Weighted  $m/s^2$ " or in decibels (dB). The weighted vibration level in decibels is 20 times the logarithm to the base ten of the ratio of a weighted acceleration to the reference acceleration. Or mathematically the acceleration is weighted in accordance with one of the four frequency weightings 0,1 - 0,63 Hz, 1 - 80 Hz (Whole Body, X and Y directions), 1 - 80 Hz (Whole Body, Z direction), 8 - 1000 Hz (Hand-Arm, all directions), and is time-weighted using RC time constants of 8 - 1 s, or linear integration of 60 s, or Peak. The reference acceleration is  $1 \mu m/s^2$ . When quoting the weighted acceleration level, the frequency weighting and linear or exponential time weighting employed for the measurements must be indicated. In vibration measurements it is often desirable to measure in more than one axis. For continuous or very repetitive signals, consecutive mea-

measurements of the x, y and z axis may be carried out and the maximum r.m.s. weighted acceleration "AW" obtained from

$$A_w = [A_{wx}^2 + A_{wy}^2 + A_{wz}^2]^{1/2}$$

Using this calculation will result in a conservative evaluation giving the maximum value which may occur. The minimum value will be represented by the largest single axis value measured. The use of 60 s. linear integrated r.m.s. detection is recommended. Alternatively, the maximum r.m.s. obtained in a specified time interval using 1 s time integration. The 1 s RC time constant should be reported as this will significantly affect the measured results when measuring signals with large crest factors. In principle, a human response vibration meter may contain the choice of signal processing and read-out, shown in Fig. 11.

An instrument developed for measurements according to these criteria, is the B & K Human-Response Vibration Meter Type 2512, the block diagram of which is also shown in Fig. 12. For more research-oriented work, it is often important to obtain more detailed information about the frequency content of the vibration being measured using filter techniques. The use of sequential switching requires a steady signal over a rather long time and is therefore time consuming and sometimes not well suited for the fluctuations we often see in vibrations influencing man. Parallel analog filter bands have shortcomings in the detector response and often misjudge rapidly varying signals.

FFT (Fast Fourier Transform) processors analyse blocks of data. It is important to realize that the block of data represents an approximation if a continuous, variable signal is analysed. Also the ultimate synthesization into 1/3 or 1/1 octaves often contains serious errors due to approximations, and the use of Hanning or other time-varying functions will make real-time data collection impossible. Accurate and non-comprising filter and detector techniques can be realized in the digital filter, which allows continuous data collection at very fast rates with no loss of integration time - linear or exponential - with a chosen confidence level.



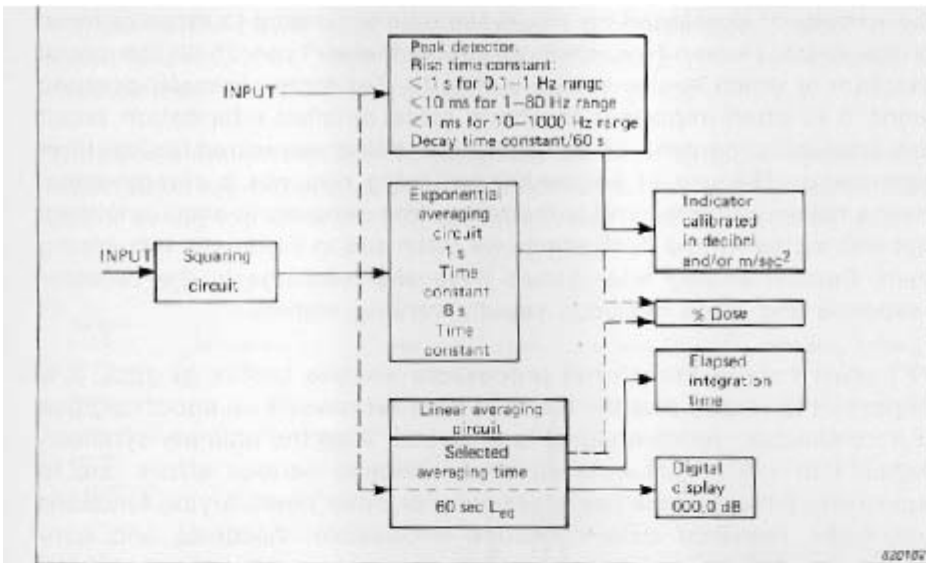

Fig. 11. Signal processing and read-out choices

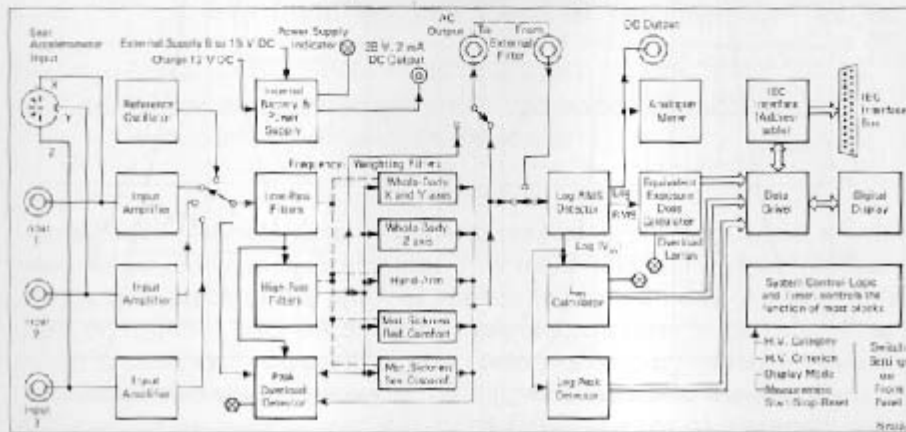
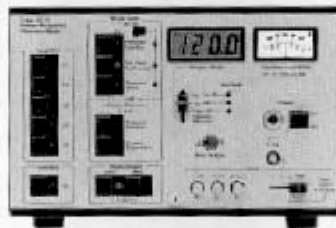

Fig. 12. Simplified schematic block diagram of the Human-Response Vibration Meter

The use of the power spectrum through 1/3 octave standardized filters which fulfil IEC 225 - 1966, DIN 45 652 and ANSI S1.11 - 1966 standards ensures easy comparison of spectra (see Fig. 13).

Vibration data in relation to influence on man is most conveniently reported on log-log scales while technical data may sometimes be most useful in log-lin or lin-lin scales. (See Figs.14 and 15).

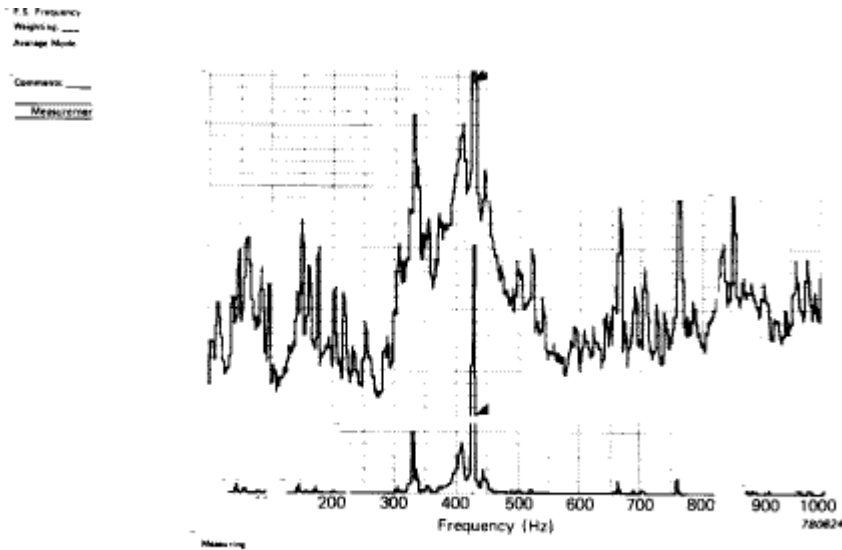

Fig. 4. Linear and logarithmic amplitude scale. Presentation of same signal on log-lin and lin-lin scales

Fig. 14.

Transducer technology is in general less of a problem when we deal with whole-body measurements. The main rule being that measurements take place at the point of application to the body. A useful guide may be found in ISO DP 5348 for mounting of seismic pickups. Also a "seat transducer" consisting of a deformable pad which follows the seat contour and containing a triaxial accelerometer for simultaneous measurements in three mutually perpendicular axes of vibration is well standardized (SAE Recommended Practice J 1013 (1973)) and will cover most whole-body measurement situations. (See Fig. 16).

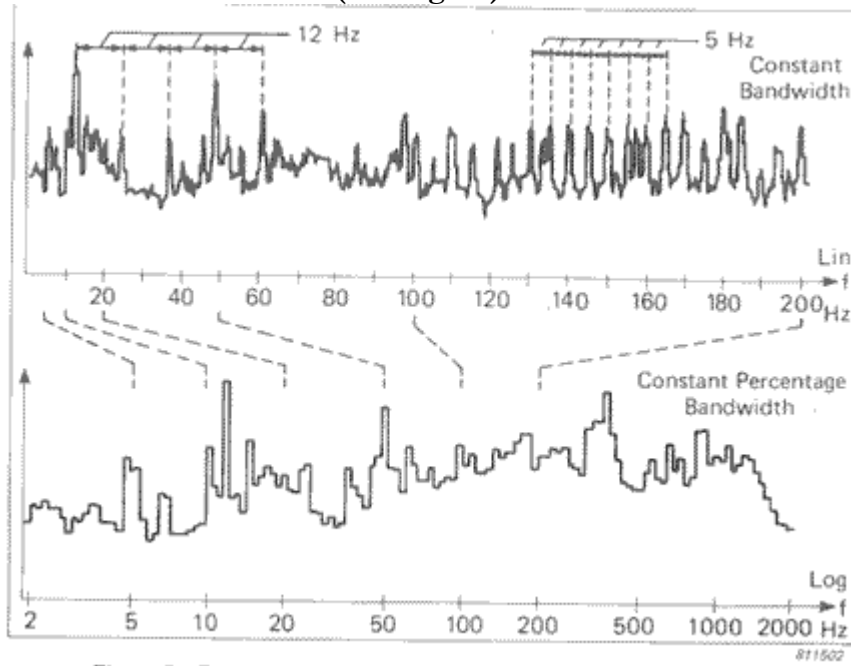
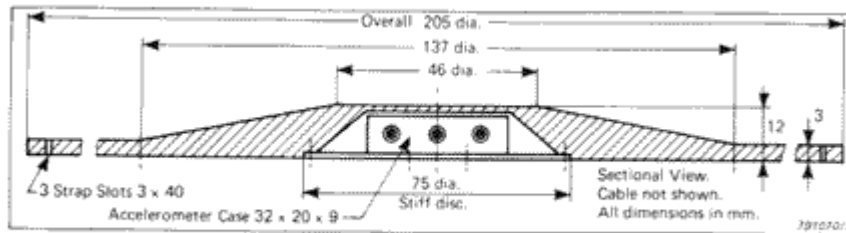

Fig. 15. Example of use of log-lin and log-log scale

*Fig. 15. Example of use of log-lin and log-log scale*



*Fig. 16. Whole-Body Seat Transducer sectional view*

Measurements according to ISO 2631 and DAM 1 as well as DAD 1 present no special instrumentation problems when proper transducer technology is chosen. In particular, one should ensure minimum base bending, cable whip, and temperature gradient sensitivity. This is even more critical in carrying out measurements in the very low frequency range, popularly referred to as "Motion Sickness", dealt with in ISO 2631 DAD 2.A four channel FM (Frequency Modulated) tape recorder is normally used for simultaneous recording of three-axis vibration ensuring better than 3,5% reproduction accuracy as also required for measurements on agricultural vehicles, and enabling frequency transformation of 1:10 for analysis by recording and replaying the signal at different speeds.

#### Hand-Arm Vibration Measurements

The measurement of Hand-Arm Vibration presents some special problems both with regard to instrumentation and transducer techniques.

Basically, 1/3 octave or 1/1 octave filtered signal levels are quoted in the relevant Draft standard. However, it is also common practice to use overall weighting filters for single number readings.

The overall weighting method has become the primary method of quoting hand-arm vibration levels for regulatory purposes, industrial hygiene applications, and single number readings for labelling of hand tools. (See Fig. 17)

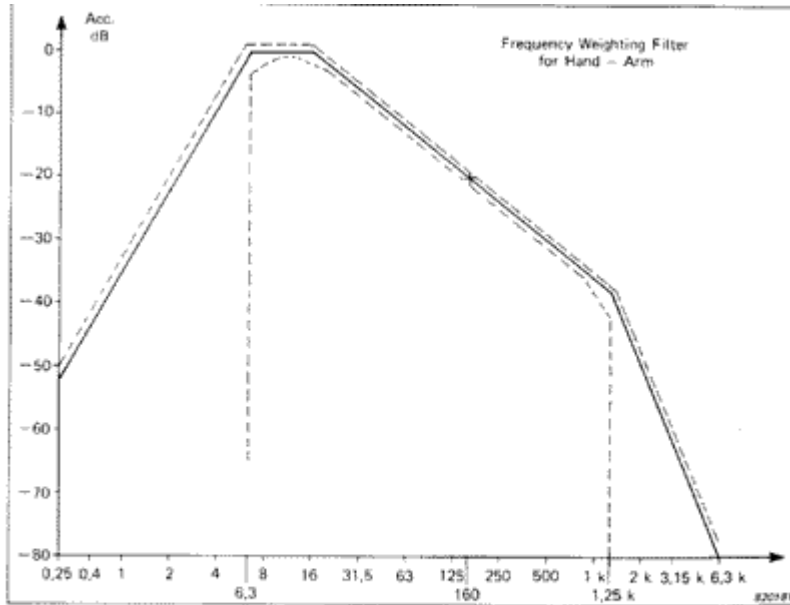

Fig. 17. Hand-Arm weighting filter characteristics

The 1/3 octave analysis method is still to be preferred for gathering data in research and practical engineering hand-arm vibration control work where high resolution of the frequency spectrum is required. The most common error in quoting 1/3 or 1/1 octave levels is introduced using results obtained from FFT analyzers. Harmonic signals or well defined random noise may very well be treated by the calculation of a block sample with good approximation to the continuous sampling technique, and the measurement of one single transient like a hammer blow is also well suited for FFT calculation. But series of transients or time varying signals like those most often dealt with on percussive tools - chain saws - pedestal grinders etc., are very difficult to assess without error even using averaging over many samples. Errors in the power spectrum at high frequencies may easily be introduced through limited block sample length.

Gathering data in the field for research purposes is most conveniently carried out using portable instrumentation with instrumentation tape recorders for subsequent laboratory examination.

*Fig. 18. [not shown] Fully portable instrumentation for field measurements*

The introduction of errors due to the very high acceleration levels experienced in idling percussive tools may cause transducer problems like zero-shift or breakdown. These errors may be eliminated using proper transducer adaptation techniques.

On transducer application the following is quoted from the draft proposal ISO/DIS 5349:

"The vibration pickup must be small and light enough for the specific application. Its cross-axis sensitivity must be at least 20 dB below the sensitivity in the axis to be measured.

The measurements in the three axes shall be made at, or clearly related to, the surface of the hand where the energy enters the body. If the hand of the person is, in direct contact with the vibrating surface of the hand grip, the transducer should be fastened to the vibrating structure. If a resilient element is being used between the hand and the vibrating structure (for example, a cushioned handle), it is permissible to use a suitable mount for the transducer (for example, a thin, suitably formed metal sheet) placed between the hand and the surface of the resilient material. In either case, care must be taken that the size, shape and mounting of the transducer or of the special transducer support do not significantly influence the transfer of vibration to the hand. Care must be taken when mounting the transducer that the transfer function is flat up to 1500 Hz for all three directions.

Notes: 1. For signals with a very high crest factor, for example those obtained from percussive tools, special precautions must be taken to avoid overloading any part of the system. Correct choice of the transducer is essential in this case. It may be possible to use a mechanical filter with a suitable calibrated linear transfer function to reduce the crest factor of these signals.

2. The proposed method for the case of a resilient element between the hand and the vibrating structure

is not satisfactory for all conditions, particularly in the case of thin cushions mainly affecting the transfer of

higher frequencies. In such cases it might be preferable to make the measurements with the transducer

rigidly attached to the handle or structure and to report separately the type, thickness, physical properties

and estimated attenuation achieved by the cushioning material.

Although characterization of the vibration exposure currently uses the acceleration (velocity) transmitted to the hand as the primary quantity, it is reasonable to assume that the biological effects might depend to a large extent on the energy transmitted. This energy depends on the coupling of the hand-arm system to the vibration source and consequently on the grip pressure applied and the magnitude and direction of the static force. Measurement of the energy transmitted to the hand and of the tool application force is feasible and desirable for research purposes and for future application to special tools, but is not yet proposed in this International Standard. For the purpose of this International Standard, the vibration exposures shall be reported for a grip pressure and static force representative of the operational application of the tool or coupling of the hand to the vibrating machinery. It must be realized that changes in coupling can affect considerably the vibration exposure measured."

In order to meet the requirements a special handle has been developed at Bruel & Kjaer. It has been important to consider the following points: a) The frequency response of the adaptor should be linear from 5 Hz to above 1200 Hz.

b) The adaptor must represent a minimum load to the hand.

c) It should be easily adaptable and measure as close as possible to the standardized reference point

on both right and left hand.

d) It should realistically reflect the used grip strength.

e) It shall never underestimate the energy transmitted to the hand from the handle.

An adaptor has been developed which covers these requirements and has been tested in various practical situations. The adaptor represents a compromise between close coupling to the handle of the work piece and close coupling to the hand.

To be on the safe side in protecting the hand, the adaptor is designed to measure more closely the vibration of the handle than that experienced on the hand itself, if any difference exists. A drawing giving main dimensions is shown in Fig. 19.

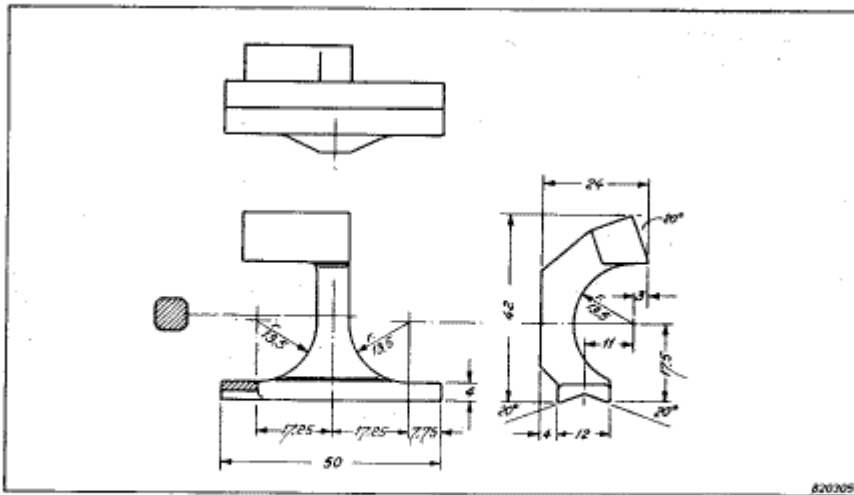
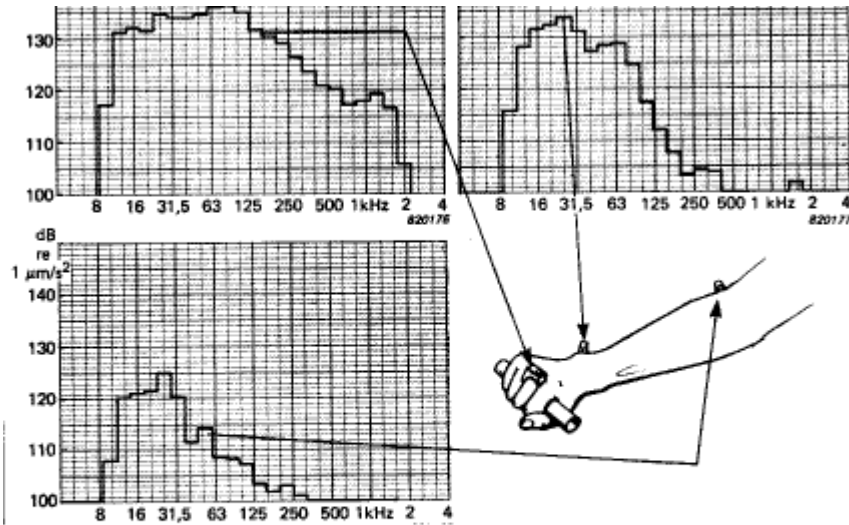

Fig. 19. Hand adaptor manufactured in lightweight metal, magnesium or aluminium alloy





*Fig. 21. Vibration level on third metacarpal, on wrist and elbow for flat pink noise spectrum on handle as shown in Fig.20.*

*Fig. 21.*

For comparison is shown the transfer function from the handle to the head of the third metacarpal, which is the standardized coordinate system reference position for the hand. (See Fig. 21).

The transfer function to the wrist (Fig. 21) and to the elbow is also shown.

Use of the proposed adaptor for hand-arm measurements is thus believed to be very safe, convenient, and to give reproducible results. Fig. 22 shows photographs of the actual test set-up for obtaining the hand-arm vibration responses shown in Figs. 20 and 21.



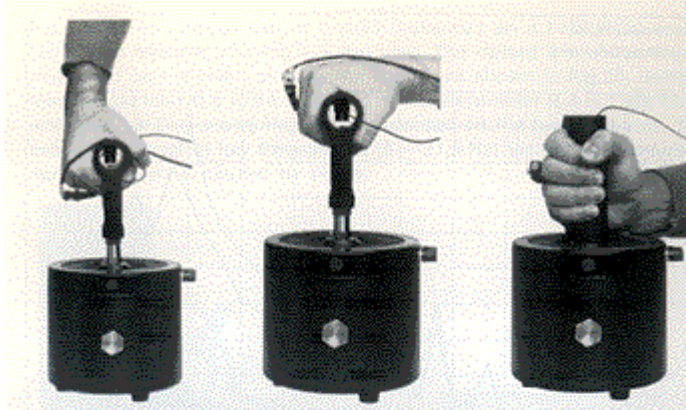

*Fig. 22. Test set-up for transfer function measurements*

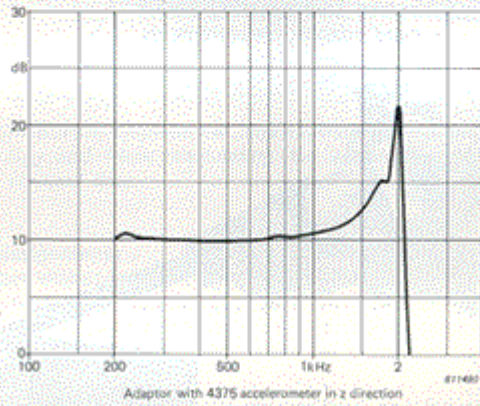

*Fig. 23. Frequency response of the adaptor on a 180 g stainless steel block*

Fig. 23 shows the performance of the adaptor under standardized response test conditions for acceleration pick-ups mounted on 180 gr. of stainless steel.

*Fig. 22. Test set-up for transfer function measurements*

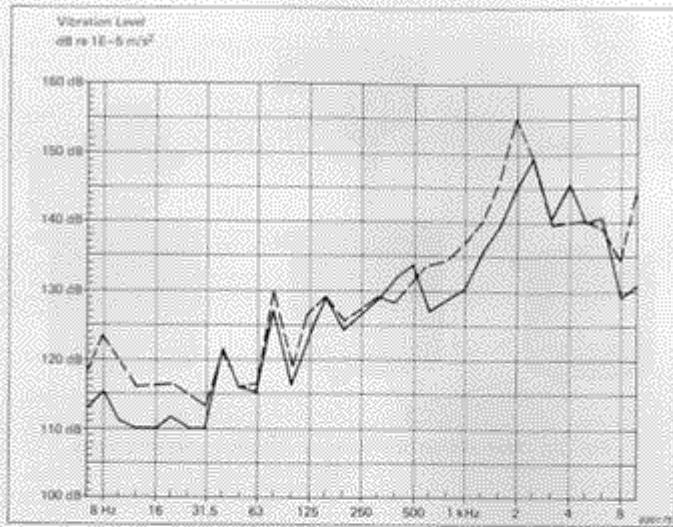

Fig. 24. PNEUROP chip hammer measurements comparing  
 ---- welded stud mounting versus  
 --- hand adaptor measurements

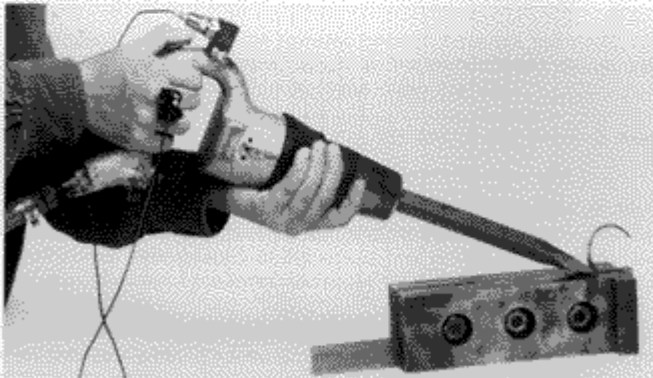

Fig. 25. PNEUROP chiphammer

Fig. 24. PNEUROP chip hammer measurements comparing ---- welded stud mounting versus  
 --- hand adaptor measurements

Fig. 24 shows comparison of results measured on a PNEUROP round robin chip hammer shaving a 2 mm chip. The dotted line shows levels measured on a welded stud on the handle as shown in Fig.25, using a mechanical filter B & K UA 0559 and an accelerometer B & K Type 4369, while the full line shows the levels measured on the hand adaptor. The increase in level at low frequencies (8 -31,5 Hz) for the stud-mounted accelerometer is caused by noise.

*Fig. 26.[not shown] PNEUROOP chiphammer measurements using overall weighting  
Leq and Peak, calculating the exposure over a measured elapsed time*

**Acknowledgements** The author wishes to thank Mr.J.R.Hassall for writing the introduction and the section on vibration exposure criteria.

**end**